

Volkswagen Cabriolet DIY Guide

Glass Components

Page 2 | 1979-1988, press-in windshield:



Page 2 | 1989-1993, press-in windshield, without airbag:







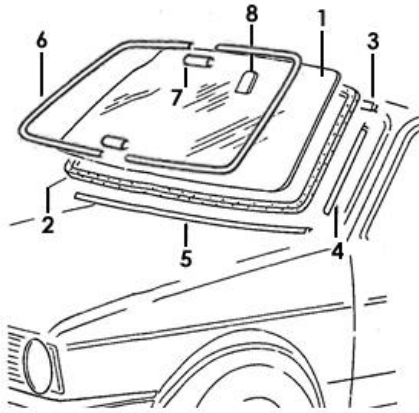

Pages 3-4 | 1990-1993, glue-in windshield, with airbag:



Windshield Components ~ 1979-1993 (press-in)



Diag. #	Component Name	Volkswagen Part #	Industry Part #	Notes	Photo Example
1	Glass (laminated)	161845101	FW332	Without mirror bracket	
			FW399	With mirror bracket	
	Glass (laminated, green tinted)	161845101A			
2	Seal/gasket	171845121	WBL332	Without molding groove	
		171845121A	WCR332	With molding groove	
3, 4	Upper & side clamping strips	321845141		Use #5 and trim to fit	
5	Lower clamping strip	811845145		Mounts to frame pinch weld	
6	Chrome molding 1979-1989	155853305 > 255853305		Supersede part is for Vanagons; 1 piece is more than enough for a Cabriolet – trim as needed	
	Black molding 1989-1993	155853299 01C		NLA	
7	Chrome molding sleeve	171853339A		Two required for original appearance (black version is NLA)	
	Black molding sleeve	155853339			
8	Mirror mounting plate	4A0845543			

Windshield ~ 1990-1993 (glue-in, airbag cars only)

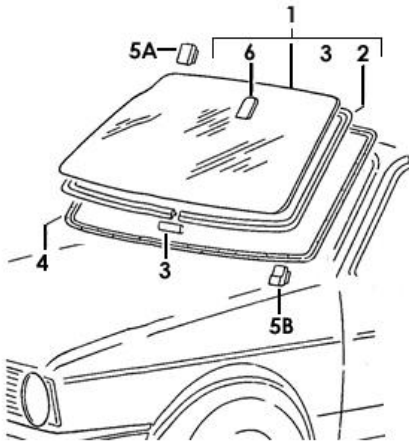

Diag. #	Component Name	Volkswagen Part #	Industry Part #	Notes	Photo Example
1	Glass (laminated, bonded)	155845011K 155845011L	FW659*	Comes with 2, 3, 6, & seal*	
2	Black Molding	155853299 01C		NLA	
3	Black Molding Sleeve	165853339B 01C		NLA	
4	Inner Rubber Weatherstrip	155853778		Available at VW Classic Parts and its retailers	
5A, 5B	Spacer	NLA			
6	Mirror mounting plate	4A0845543			

*As of February 2012, these windshields now come as glass only with a universal gasket/seal (seen below), which can lead to water leaks if not installed properly. If you go this route, be sure to observe the installation to ensure the gasket is bonded to the glass and properly glued to the windshield frame/inner weatherstripping and that the seal is smooth, is laying flat, and doesn't have any ripples.



Update 2017: While the bonded windshield unit is NLA, you can order the glass (FW659), two inside moldings (WKT1027), and one outside molding (ET107BFL) to retrofit. Installation: The inside moldings are glued to the windshield frame, joined at center top and bottom. Windshield is glued to the inner molding, followed by gluing the outside molding to the windshield, joined at center bottom. *(Thank you to Robert S. for this info!)*

Press-in windshield retrofit: See next page.

Press-in Windshield Retrofit, 1990-1993 airbag cars



Components needed (refer to page 2):

- Press-in glass
- Press-in seal (without molding groove)
- Clamping strips (not required, but recommended)

Before installation:

- Remove inner weatherstrip (identified by white arrows below) seal/gasket completely
- Remove inner spacers (#5 on page 3), if present
- Windshield frame should be 100% clean all the way around – no adhesive, no rust, no paint chips, etc.
- Windshield frame should have no bare metal – primer and paint if necessary
- Windshield frame should have no anomalies such as dents, bent metal, etc.

Installation:

- Prep: [How to Install a VW Rabbit/Cabriolet Windshield, Part 1](#) 
- Install: [How to Install a VW Rabbit/Cabriolet Windshield, Part 2](#) 

After installation:

- There may be a visible $\frac{1}{8}$ " to $\frac{1}{4}$ " gap between the gasket/seal and the textured vinyl A-pillar trim covering (trim identified by blue arrows below). This is merely aesthetic, not structural. If you think this small gap will be unpleasant to your eyes, deal with it **before** glass installation.

A-pillar, 1979-1993, **without** airbag:







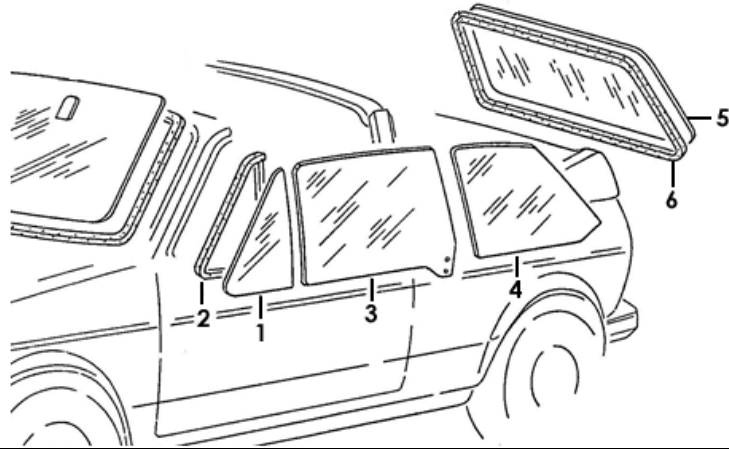

A-pillar, 1990-1993, **with** airbag:



Side & Rear Windows ~ 1979-1993



Diag. #	Component Name	Volkswagen Part #	Industry Part #	Notes	Photo Example
1	Vent window glass (fixed)	171845251		Left, clear	
		171845251A		Left, green-tinted	
		171845252		Right, clear	
		171845252A		Right, green-tinted	
	Vent window glass assembly (opening, bolt-thru)	171845245M		Left, clear	
		171845245P		Left, green-tinted	
		171845246M		Right, clear	
		171845246P		Right, green-tinted	
2	Seal/gasket, vent window (fixed)	171845261A		Left, with molding groove	
		171845262A		Right, with molding groove	
		171845261		Left, without molding groove	
		171845262		Right, without molding groove	
	Seal/gasket, vent window (opening, bolt-thru)	NLA		Left, with molding groove	
		NLA		Right, with molding groove	
		171837529B		Left, without molding groove	
		171837530B		Right, without molding groove	
3	Door window glass	155845201D		Left, clear	
		155845201E		Left, green-tinted	
		155845202D		Right, clear	
		155845202E		Right, green-tinted	
4	Rear side window glass	155845301		Left, clear	
		155845301A		Left, green-tinted	
		155845302		Right, clear	
		155845302A		Right, green-tinted	

5	Rear window glass, heated	155845501		Clear	
		155845501A		Green-tinted	
6	Rear window seal/gasket	155845521			

NLA = no longer available

*** The information contained in this document is for reference/entertainment use only and may contain accidental inaccuracies. Be sure to double-check all part numbers and/or equipment prior to ordering and installing any of these components. Remember: **You** are responsible for **your** car. Cabby-Info.com, KamzKreationz, VAG, VWoA, or anyone else are not responsible if anything goes wrong while **you** or your technicians are working on, in and under **your** car! Use this information at **your** own risk!***